



B470 Barbecue Island with G4 Grill

United States and Canada

© 2023 Lloyd's Material Supply Company, Inc.

Owner's Manual



Table of Contents

Safety Instructions 1
Preparing the Site for the Barbecue Island 3
Installation and Connection 8
Using Your Grill 13
Optional Grill Accessories 17
Cleaning and Maintenance 20
Appendix 25

WARNING

If the information in this manual is not followed exactly, a fire or explosion may result causing property damage, personal injury or loss of life.

Do not store or use gasoline or other flammable vapors and liquids in the vicinity of this or any other appliance.

Do not store an LP cylinder not connected for use in the vicinity of this or any other appliance. A fire resulting in serious injury or death may occur.

If you are installing a natural gas grill, you are responsible for ensuring that the natural gas line installed is safe to use. Lloyd's Material Supply Company, Inc. will not be held responsible for an improperly installed gas line.

**Read all instructions before you
operate your grill**

Save these instructions!



WARNING! Proposition 65 Warning: Handling the brass material on this product exposes you to lead, a chemical known to the State of California to cause cancer, birth defects or other reproductive harm. (Wash hands after handling this product.)

This product and the fuels used to operate this product (propane or natural gas), and the products of combustion of such fuels, can expose you to chemicals including Benzene, which is known to the state of California to cause cancer and birth defects or reproductive harm.

For more information go to www.P65Warnings.ca.gov.

Copyright 2023 LMS. All rights reserved. Duplication without written consent is strictly prohibited. Cal Flame™ is registered trademark.

Due to continuous improvement programs, all models, operation, and/or specifications are subject to change without prior notice.

LTR50001146, Rev. H
5/31/2023

250-465

CONTACT INFORMATION

For customer service, please contact your authorized dealer immediately. If you need additional information and/or assistance, please contact:

Lloyd's Material Supply Company, Inc.
Customer Service Department
1462 East Ninth Street
Pomona, CA 91766.

Toll Free: 1-800-225-7727
Fax: 1-909-629-3890

WARNING: Improper installation, adjustment, alteration, service or maintenance can cause injury or property damage. Read the installation, operating and maintenance instructions thoroughly before installing or servicing this equipment.

Placement and Location

- ⚠️ **Cal Flame™ grills are designed for outdoor use only.**
- ⚠️ Never locate this appliance in an enclosed room, under a sealed overhead structure, or in any type of enclosed area such as a garage, shed, or breezeway. Keep clear of trees and shrubs.
- ⚠️ Do not place this grill under or near windows or vents that can be opened into your home.
- ⚠️ Cal Flame™ grills are not intended for installation in or on recreational vehicles or boats.
- ⚠️ Maintain sufficient distance as to not overheat any overhead combustible material such as a patio cover.
- ⚠️ The area surrounding your new grill should be kept clean and free from flammable liquids and other combustible materials such as mops, rags or brooms, as well as solvents, cleaning fluids, and gasoline.
- ⚠️ Do not use the grill, grill cabinet, or area surrounding the grill as a storage area for flammable or plastic items. Do not store the liquid propane (LP) cylinder in the vicinity of this or any other appliance when it is not being used.

Set-Up

- ⚠️ Before installing built in grills in enclosures, copy all product information such as model number, serial number and type of grill (e.g., natural gas or LP) and store information in a safe place. This information is located on a plate located behind

DANGER ⚠️

What To Do If You Smell Gas

- Shut off gas to the appliance.
- Extinguish any open flame.
- Open lid.
- If odor continues, keep away from the appliance and immediately call your gas supplier or your fire department.

the grill and is visible when the hood is lowered or on the right side of the chassis. There is an area on the back cover of this manual where you can write down this information.

- ⚠️ We recommend that a licensed contractor install your Cal Flame™ grill. Installation must conform to local codes, or in the absence of local codes, with either the *National Fuel Gas Code*, ANSI Z223.1 / NFPA54, *Natural Gas and Propane Installation Code*, CSA B149.1, or *Propane Storage and Handling Code*, B149.2), as applicable.
- ⚠️ To prevent fire and smoke damage, remove all packaging material before operating grill.
- ⚠️ Before you start cooking, clean the entire grill thoroughly with hot, soapy water. This is necessary to remove residual solvents, oil and grease used in the manufacturing process. The grates should also be thoroughly cleaned in the same manner.

Operation

- ⚠️ Do not use grill for other than intended use.
- ⚠️ In the event that a burner goes out, turn burner knobs to the full OFF position, fully open the grill hood and let it air out. Do not attempt to use the grill until the gas has had time to dissipate.
- ⚠️ Never use the grill if the drip pan is not properly installed. Drip pan should be pushed all the way to the rack located just under the grill. Fire or explosion can result from an improperly installed drip pan.
- ⚠️ Never use the grill in windy conditions. If used in a consistently windy area a windbreak will be required. Always adhere to the specified clearances listed in this manual.
- ⚠️ Keep any electrical supply cords and the fuel supply hose away from any heated surfaces.
- ⚠️ Never line the grill with aluminum foil.
- ⚠️ When the unit is not in use, be sure to turn off the gas at the LP tank.
- ⚠️ Do not install or operate your grill unit in such a manner that the cross ventilation openings are blocked. Fresh air must be able to pass through installed vents to safeguard against residual gas accumulation. Failure to allow proper ventilation may cause fire or explosion.

- ⚠ When handling LP gas line and connectors, do not allow them to come in contact with any metal surfaces of the cabinet. Do not drop LP connectors.
- ⚠ Do not use fuel such as charcoal briquettes in gas grills.
- ⚠ Gas sources to the grill must be regulated. Do not operate grill if regulators have been removed, fire or explosion can occur.
- ⚠ Never leave the grill unattended when in use. When using pots and pans, boil-overs will cause smoking and greasy boil-overs may ignite.
- ⚠ Always use the proper size pan. Select utensils with flat bottoms large enough to cover the burner. The use of under-sized utensils exposes the sides of the utensils to direct contact with a portion of the flame. This can scorch utensils and hamper cleanup. Excessive flames on large stainless steel pots can result in permanent discoloration. For best results, we recommend commercial quality aluminum pans and utensils.
- ⚠ Always position handles of utensils so they do not extend over adjacent work areas or cooking areas. This reduces the risk of burns, ignition of flammable materials, and spillage due to accidental contact with the utensils.
- ⚠ Do not use water on grease fires. Never pick up a flaming pan. Turn the appliance off and smother the flaming pan with a tight-fitting lid, a cookie sheet or a flat tray. For flaming grease outside of the pan, smother it with baking soda or use a dry chemical or foam-type fire extinguisher.
- ⚠ Never allow clothing, pot holders or other flammable materials come in contact with or be close to any grate, burner or hot surface until it has fully cooled. Never wear loose fitting or hanging garments while using your grill. Fabric may ignite and result in personal injury.
- ⚠ When using the grill, do not touch the grill rack, burner grate, or immediate surroundings as these areas become extremely hot and can cause burns. Use handles or knobs.
- ⚠ Only use dry pot holders and do not use a towel or other bulky cloth in place of pot holders. Moist or damp pot holders used on hot surfaces can cause burns.
- ⚠ Do not heat any unopened glass or metal container of food on the grill. Pressure may build up and

cause the container to burst, possibly resulting in serious personal injury or damage to the grill.

- ⚠ Do not reach over your grill or any other surfaces when hot or in use.

Maintenance and Repair

- ⚠ Spiders and other insects can nest in the burners of the grill and block the gas and airflow to the burner ports. This creates a dangerous condition that can result in a fire behind the valve panel. Inspect and clean the burners periodically and follow the guidelines in the Cleaning and Maintenance section of this manual.
- ⚠ Unless specifically recommended in this manual, do not repair or replace any part of the grill. A qualified technician should perform all service. Any repairs made by a non-L.M.S. approved dealer technician will void your warranty.

Storage

- ⚠ When your gas grill is not in use, turn off the gas at the supply cylinder.
- ⚠ Storage of a grill indoors is permissible only if the supply cylinder is disconnected and removed.

Precautions Regarding Children

- ⚠ Never leave children unattended in the area where the grill is being used. Close supervision of children is necessary when any appliance is use near children.
- ⚠ Do not store items of interest to children around or below the grill.
- ⚠ Never allow children to sit or stand on any part of the grill.

Preparing the Site for the Barbecue Island

The Cal Flame G4 grill is expected to be use with a Cal Flame barbecue island. If the G4 grill used separately from barbecue island that it is sold with, it must be used in a safe manner that will not void your warranty. If you plan to do this, contact Cal Flame customer service for information on the construction and materials required for the grill enclosure. Cal Flame wishes our customers to enjoy our products safely and without voiding the warranty.

Placing your barbecue island in a safe location

Here are some of the things that you will need to know when determining where to place your new barbecue island. Be certain that your installation will meet all city and local safety codes and requirements.

Cal Flame grills are designed for outdoor use only.

Enclosures and Awnings



Do not locate your barbecue island in an enclosed area, which is any covered area that is walled on two, three, or four sides. This includes areas or rooms such as a garage, shed, breezeway, patio, cabana, etc.

Although some enclosed areas may have windows, screens, or ventilation systems, they are nevertheless considered to be hazardous and may cause damage, injury, or death. Enclosed areas are NOT approved for a barbecue island.

Do not locate your barbecue island under a sealed overhead structure. Acceptable overhead structures allow for airflow, such as screen or lattice.

You can install an awning over your barbecue island, provided you make sure it is high enough to prevent damage or fire. We recommend a minimum overhead distance of six feet from the top of the grill hood.

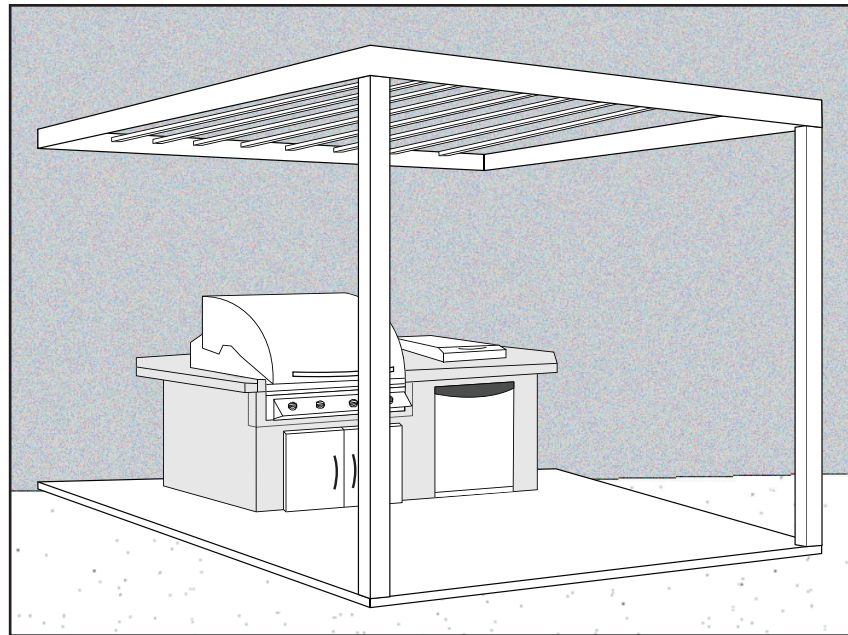

- **Solid foundation**
- **Open on three sides**
- **Minimum distance of six feet overhead from combustible material**
- **Overhead is not sealed**
- **Not placed near windows**
- **No overhead storage**
- **No combustible materials stored nearby**

Ventilation and Access

Locate the barbecue island any place where there is adequate ventilation. The size and configuration of your house and yard will determine how you should locate your barbecue island, but as a general rule, do not place it under or near windows that can be opened into your home.

If you place your barbecue island close to a wall or fence, make sure you allow room for ventilation. Also, make sure you have easy access to the storage under the grill and to the refrigerator.

Overhead Hazards

Do not place your barbecue island near trees and shrubs.

Maintain sufficient distance as to not overheat any overhead combustible material.

Maintain sufficient distance as to not overheat any overhead combustible material. We recommend a minimum distance of six feet, measured from the top of the grill hood. Check with local inspectors and your homeowner's association.

To reduce the risk of personal injury caused by reaching over a hot appliance, avoid locating cabinet storage space directly above the outdoor grill.

Plan for Your Environment

Consider factors such as exposure to wind, proximity to traffic paths, and windows that open into the home.

Access to gas lines should be considered. If you are using natural gas, the location with the shortest gas line run is recommended.

Preparing a Good Foundation

Your barbecue island needs a solid and level foundation. Damage caused by inadequate or improper foundation support is not covered by the warranty. It is the responsibility of the owner to provide a proper foundation for the barbecue island.

If you do not already have a location for your barbecue island, we recommend you have a concrete slab prepared to accommodate it. There are several advantages of having a permanent slab, including stability, levelness, and it eliminates sagging.

As you prepare your slab, this is the best time to run gas and electrical service stub-ups for your barbecue island to connect to. The size and shape of the base of the barbecue island is called a footprint. It also shows suggested locations for your stub-ups.

Although a permanent slab is recommended, you can place your barbecue island on a prepared surface with bricks or pavers. We do not recommend you place your barbecue island on gravel, sand, timbers, dirt or grass because these surfaces have the potential to become unstable or uneven. Your barbecue island should always be on a stable, flat, level surface. Damage due to placing the island on an improper foundation is not covered under your warranty.

You can put your barbecue island on a deck provided it is rated to support the full weight of your barbecue island, grill, and all accessories. We recommend you have a contractor or structural engineer examine your deck to determine whether it can bear the load of your barbecue island.

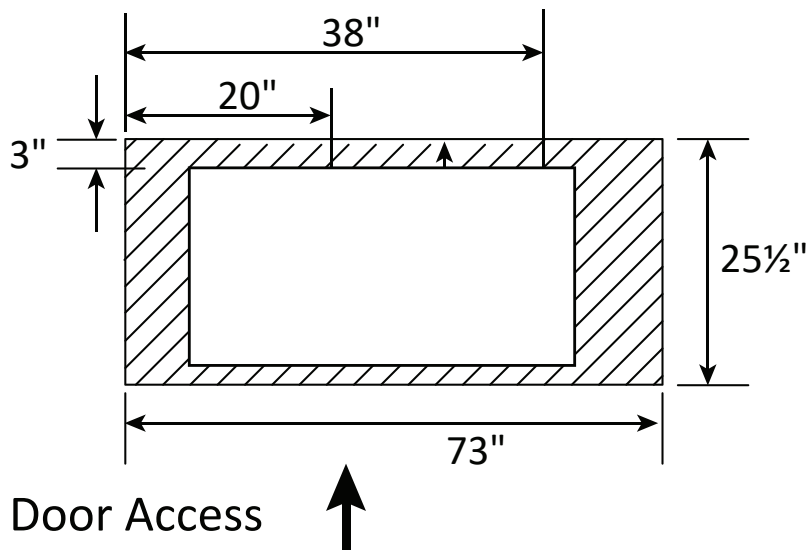

Electrical Requirements

You do not need to hire a contractor to install your electrical service, but you must ensure you have all required permits and the installation complies with State and local code. We recommend you hire a certified contractor if you do not wish to do the installation yourself.

If your dealer is not a certified contractor, you will need to hire a contractor for installation of your electrical service.

When installed in the United States, the electrical wiring must meet the requirements of National Electric Code, ANSI/NFPA 70-1999 and any applicable state or local codes. The electrical circuit must be installed by an electrical contractor and approved by a local building / electrical inspector.

Supplying power to a barbecue island that is not in accordance with these instructions will void both the independent testing agency listing and the manufacturer's warranty.

The power supplied to the barbecue island must be on a dedicated circuit with no other appliances or lights sharing the power.

To determine the current, voltage, and wire size required for the island configuration to be connected,

refer to the following:

- Wire size is determined by length of run from breaker box to the barbecue island and maximum current draw.
- We recommend copper wire with THHN insulation.
- All wiring must be copper to ensure adequate connections. Do not use aluminum wire.
- When NEC requires the use of wires larger than #6 (10mm²), install a junction box near the barbecue island and use #6 (10mm²) wire between the junction box and the barbecue island.

120 Volt Electrical Installation

For 120V grills, you need a dedicated 120V 10 amp grounded electrical service.

There will be a 110V power outlet inside the barbecue island. Using romax or similar grounded, shielded wire, connect the outlet to the electrical service in the stub-up.

If the circuit breaker trips while the barbecue island is in use, reset it. If it does not reset, contact a licensed electrician for service. **DO NOT USE THE BARBECUE ISLAND!**

Gas Requirements

Converting Gas Grills

IMPORTANT: Cal Flame G Series gas grills are manufactured to operate on liquid propane (LP). However, they can be converted to operate on natural gas (NG) by an authorized service technician. The grill that comes with your B470 barbecue island does not include the parts for converting to NG. The gas conversion kit for Cal Flame grills can be ordered separately. Grill conversion instructions can be found on page 27 and ordering information can be found in this manual on page 29. The part number for the conversion kit is BBQ07101045.

Liquid Propane

Tank Requirements

For plumbed-in LP installation, use a convertible regulator and set it for LP gas.

Maximum line pressure for plumbed-in propane is 14" WC (3.5 kPa). Minimum line pressure for propane is 11" WC.

The grill must be used with the gas pressure regulator. The regulator will control and maintain a uniform gas pressure in the manifold. The burner orifices have been sized for the gas pressure delivered by the regulator.

WARNING: Attempting to operate the grill unit without the gas regulator installed could cause an explosion and possible death.

Cylinder Specification

The LP cylinder must be constructed and marked in accordance with the *Specifications for LP-Gas Cylinders* of the U.S. Department of Transportation or the National Standard of Canada, *CAN/CSA-B339, Cylinders, Spheres and Tubes for Transportation of Dangerous Goods; and Commission*, as applicable.

Any LP gas supply cylinder used with this grill must be approximately 12 inches in diameter and 18 inches high.

The maximum fuel capacity is 20 lbs. of propane, or 5 gallons. Full cylinder weight should be approximately 38 lbs. (43.7 lbs. nominal water capacity.) Never fill the cylinder beyond 80% full.

If you do not have an updated filler valve on your existing propane tank, you will need to purchase one at your local hardware store. Without it you will not be able to attach your tank to your grill or refill the tank at your local propane refill station.

Transporting and Storing LP Gas

Transport only one cylinder at a time. Ensure the cylinder is secured in an upright position with the control valve turned off and the dust cap in place. Store cylinders outdoors and out of reach of children. Do not store cylinders in a building, garage, or any other enclosed area.

Place the dust cap on the cylinder valve outlet whenever the cylinder is not in use. Only install the type of dust cap on the cylinder valve outlet that is provided with the cylinder valve. Other types of caps or plugs may result in leakage of propane.

Natural Gas

NG Service Installation and Connection

Natural gas installation of this appliance must conform with local codes or, in the absence of local codes, to the national fuel gas code, ANSI Z223.1a-1998. Installation in Canada must be in accordance with the standard CAN/CGA-B149.2, Propane Installation Code.

You do not need to hire a contractor to install your natural gas service, but you need to make sure you have all required permits and ensure the installation complies with State and local code. We recommend you hire a certified contractor if you do not wish to do the installation yourself.

The natural gas pipe from your house to the location of your barbecue island needs to be $\frac{3}{4}$ " and terminate with a shut-off valve with a $\frac{1}{2}$ " male fitting. Check with a contractor or your local inspector for requirements.

Always check the rating plate to make sure the gas supply you are hooking up to is the gas type the grill is manufactured for.

NG Regulator

The grill for use with natural gas comes equipped with its own regulator that **MUST NOT** be removed. If this regulator needs to be replaced, use only the type specified by for this appliance.

IMPORTANT: Never connect the grill to an unregulated gas supply.

Shut-off Valve

Ensure that the service supplying the grill is fitted with a shut off valve conveniently positioned near the grill and giving ease of access.

The grill must be isolated from the gas supply piping system by closing its individual manual shutoff valve during any pressure testing of the gas supply piping system at test pressures equal to or less than 0.5 psi (3.5 kPa).

Installation and Connection

Installation Check-Off List

Use this table to guide you with the installation of your barbecue island. Follow these steps in sequence.

	1. Prepare a proper foundation with stub-ups.	page 8
	2. Place the grill in the cut-out.	page 9
	3. Connect gas line to grill.	page 10
	4. Connect to gas source.	page 11

You may need a second person to help you to avoid damaging the grill or your barbecue island.

1. Prepare a proper foundation with stub-ups.

Your barbecue island needs a solid and level foundation. Damage caused by inadequate or improper foundation support is not covered by the warranty. It is the responsibility of the owner to provide a proper foundation for the barbecue island.

If you do not already have a location for your barbecue island, we recommend you have a concrete slab prepared to accommodate it. There are several advantages of having a permanent slab, including stability, levelness, and it eliminates sagging.

As you prepare your slab, this is the best time to run gas, electrical, and water lines and locate stub-ups for your barbecue island to connect to. The size and shape of the base of the barbecue island is called a

footprint.

Although a permanent slab is recommended, you can place your barbecue island on a prepared surface with bricks or pavers. We do not recommend you place your barbecue island on gravel, sand, timbers, dirt or grass because these surfaces have the potential to become unstable or uneven. Your barbecue island should always be on a stable, flat, level surface.

You can put your barbecue island on a deck provided it is rated to support the full weight of your barbecue island, grill, and all accessories. We recommend you have a contractor or structural engineer examine your deck to determine whether it can bear the load of your barbecue island.

2. Place the grill in the cut-out.

You may need a second person to help you with the step.

Remove the grill from its packaging and place it in the cut-out.

Keep your fingers away from where the grill will be supported on counter. Your fingers could become trapped and injury could occur.

Place the grill in the cut-out so that it is supported by the lip on the left and right sides. When it is in place, slide it all the way back as shown below. Check to make sure the grill is level and is supported around the entire outside edge.



3. Connect gas line to grill.

Slide the grill forward about six inches.

Connect the gas line to the grill using the appropriate connection for your gas type.

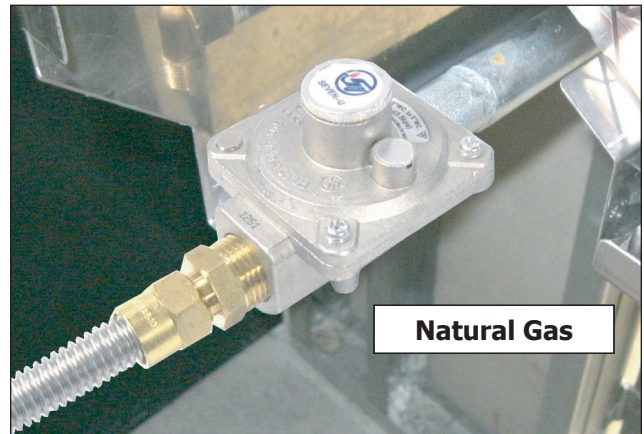
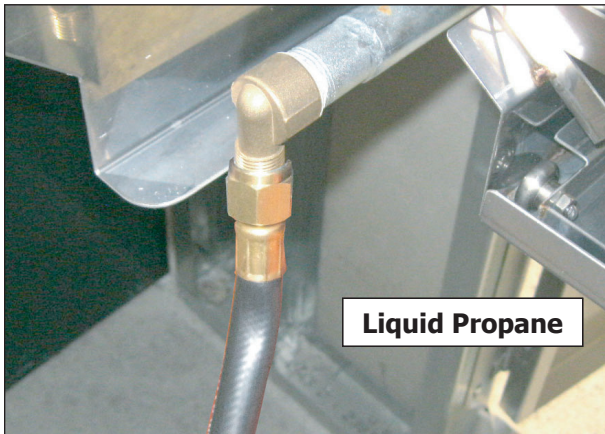
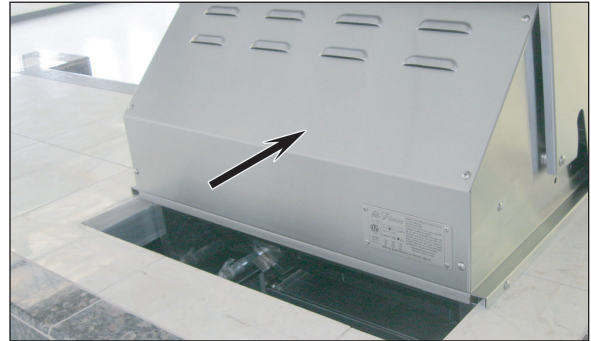

Note: Make sure you have converted the grill for natural gas before connecting the gas line to the regulator. See page 27 for instructions on converting the grill from LP to NG.

4. Connect to gas source.

Liquid Propane Connection

Use the pressure regulator and hose assembly supplied with the grill, or a regulator and hose assembly with the same specifications. Replacement LP regulator and hose must have a coupling nut that will connect to a QCC-1 cylinder valve on one end and a female fitting that will connect to a 3/8" tapered fitting on the grill manifold. See the figures below.

Connect the brass fitting to the manifold behind the grill. Do not use Teflon tape or plumber's dope. Do NOT remove the NG regulator from the manifold. Connect the coupling nut to the LP cylinder valve.

When you are finished connecting to the gas source, perform a leak test.

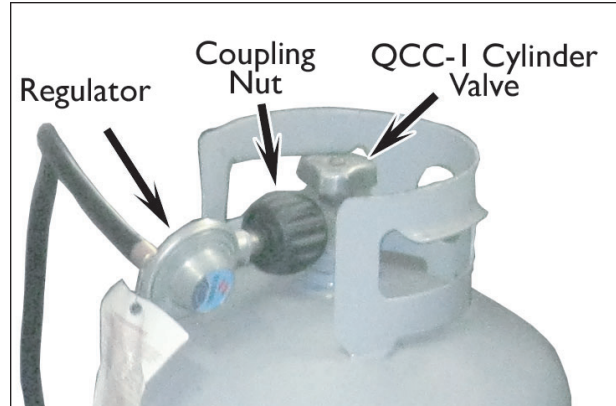

Gas Cylinder Orientation

LP gas cylinder must be up oriented upright during operation for proper vapor withdrawal. Operating the grill with the cylinder on its side will allow liquid gas to flow into the regulator. Erratic gas flow will occur, resulting in possible flare-ups or explosion.

Natural Gas Connection

Connect the gas line to the NG stub-up inside the barbecue island. When you are finished connecting to the gas source, perform a leak test.

Leak Testing Procedure

Perform a leak test at least once a year whether the gas supply cylinder has been disconnected or not. In addition, whenever the gas cylinder is connected to the regulator or whenever any part of the gas system is disconnected or replaced, perform a leak test.

As a safety precaution, remember to always leak test your grill outdoors in a well-ventilated area. Never smoke or permit sources of ignition in the area while doing a leak test. Do not use a flame, such as a lighted match to test for leaks. Use a solution of soapy water.

1. Prepare a leak testing solution of soapy water by mixing in a spray bottle one part liquid soap to one part water.
2. Make sure all the control knobs are in the OFF position.
3. Turn on the gas.
 - a. On natural gas systems, turn the main feed valve to the grill.
 - b. On LP systems, turn the cylinder valve knob counter clockwise one turn to open.
4. Apply the leak-testing solution by spraying it on joints of the gas delivery system. Blowing

bubbles in the soap solution indicates that a leak is present.

5. Stop a leak by tightening the loose joint or by replacing the faulty part with a replacement part recommended by the manufacturer. Do not attempt to repair the cylinder valve if it is damaged. The cylinder must be replaced.
6. Turn all control knobs back to the full OFF position.

If you are unable to stop a leak:

1. Turn all control knobs back to the full OFF position.
2. Shut off the gas supply to the grill and release pressure in the hose and manifold by pushing in and turning any of the control valves one quarter turn counter-clockwise.
3. On LP systems, remove the cylinder from the grill.
4. Call an authorized gas appliance service technician or an LP gas dealer.

Do not use the appliance until the leak is corrected.

Read all instructions before you operate your grill.

We recommend you wash your entire grill with soap and water prior to lighting it for the first time. Oils are used during the manufacturing process and some residual oil may still be on the stainless steel parts of your grill. Washing will reduce the possibility of discoloration. We also recommend you keep your grill covered when not in use. This will minimize the amount of dust and dirt that accumulates on your grill and extend the life of your grill.

Remember to use your Cal Flame grill safely by following these reminders:

- It is dangerous to use barbecue grills in any manner other than for what it is designed for.
- Do not use charcoal in a gas grill.
- Do not heat sealed containers such as cans or jars on grills. Explosion may result resulting in injury or death. Any sealed container, such as a pressure cooker, must have a properly operating pressure relieve valve to minimize explosion hazard.
- Never put combustible material such as paper, cloth, or flammable liquids on your grill at any time. Do not use grill, side shelves, cabinets, or any area around grill to store flammable materials.

Grill Controls

The controls shown below are for the G4 grill. Familiarize yourself with these controls before using your Cal Flame™ barbecue.

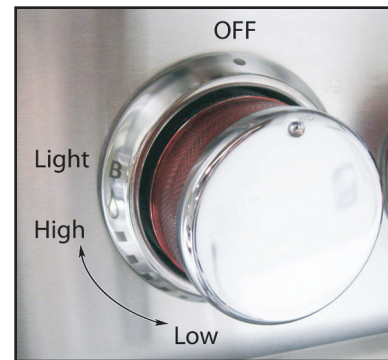
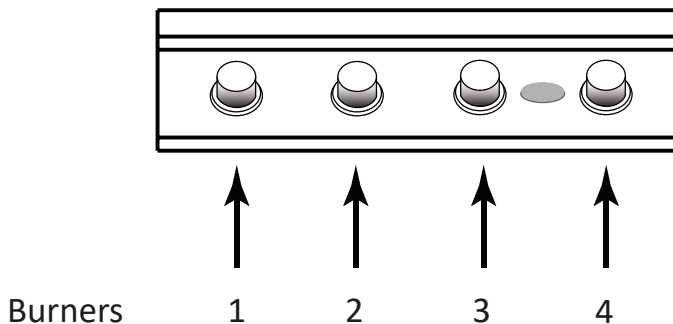

Warning

NEVER cover the entire cooking or grill surface with griddles or pans. Overheating will occur and burners will not perform properly when combustion heat is trapped below the cooking surface.

CAUTION: NEVER spray water on a hot gas unit. This may damage porcelain or cast iron components.

Lighting the Burners

Each time you light the grill, check the following:

- Inspect the hose before using the grill. If there is excessive abrasion or wear, or if the hose is cut, it must be replaced prior to using the grill. See page 6 for LP connection instructions and specifications. If you need a replacement hose, contact your Cal Flame dealer.
- Ensure the area around the barbecue is clear of flammable substances such as gasoline, yard debris, wood, etc.
- Ensure there is no blockage of the airflow through the vent space located below the face of the unit.
- When using propane gas, keep the special ventilation openings in the enclosure free and clear of debris.
- If connected to a propane cylinder, carefully inspect the rubber hose attached to the regulator before each use.
- Ensure the propane cylinder, regulator, and rubber hose are installed in a location not subject to heating above 125° F (51° C).
- Ensure the burner flames burn evenly along both sides of each burner with a steady flame (mostly blue with yellow tipping). If burner flames are not normal, check the orifice and burner for insects or insect nests.
- Ensure the in-line gas valve or gas cylinder valve is always shut OFF when the barbecue is not in use.

Electronically Lighting the Burners

1. Open the hood.
2. Keep your face as far away from the burners as possible.
3. Press and rotate the burner knob counter clockwise past the light position to HIGH. You will hear a loud click as the electronic lighter produces a spark.
4. Listen for the sound of the gas igniting. If the burner does not light on the first try, repeat immediately.
5. If the burner does not light after three attempts, turn the control knobs to the OFF position. Wait five minutes until the gas clears before attempting to light it again.
6. Repeat the procedure or try the manual lighting procedure below.
7. Upon successful lighting, repeat the process on the other burners you wish to light.
8. To shut off the burners, rotate the knob and turn to OFF. It is normal to hear a popping sound when the burners are turned off.

Manually Lighting the Burners

WARNING: Do not use standard matches or cigarette lighters to perform match lighting procedures. Serious burns can occur and lighters can explode.

1. Open the hood.
2. If you have just attempted to light the burner, allow five minutes for any accumulated gas to dissipate.
3. Slide out the drip tray from the grill.
4. Keep your face as far away from the burners as possible.
5. Light and insert a long stem match, holding it near the burner ports.
6. Push in and turn the control knob just past the LIGHT position to HIGH.
7. Listen for the sound of the gas igniting. If the burner does not light after five seconds, turn the control knobs to the OFF position. Wait five minutes until the gas clears before attempting to light it again.
8. If the burner does not light after several attempts see Troubleshooting Guide in the back of this manual.

Basic Grill Operation

Before lighting, make sure all burner controls are off. Do not attempt to light the burners if the smell of gas is present. Check the connection with a soap and water solution after attaching the hose. For LP units, make sure there is gas in the tank and it is sitting upright. For natural gas units, make sure the shut off valve is on.

1. Make sure the drip tray is in place.
2. Light the grill burners using the instructions on the previous page.

3. Turn the control knob to HIGH and preheat the grill for 15 minutes. Close the top cover during the appliance preheat period.
4. Place the food on the grill and cook to desired completion. Adjust heat setting if necessary. You may set the control knob to any position between HIGH and LOW.
5. Allow the grill to cool and clean the drip tray after each use.

Do not leave the grill unattended while cooking.

Proper Burner Flame

Flame Color and Height

The burner flame has been set in the factory and should already be adjusted for proper height and intensity. Periodically, you may wish to check each burner's flame for color, height, and intensity. Remove the grill rack and the flame tamer over the burner you want to inspect.

When the burner is operating properly, the flame will appear between light to dark blue, with occasional yellow bursts (due to impurities in propane -- this is normal).

When the burner is set on high, the flame spread out about 1/2" away from the side of the burner. (See top figure at right.)

When the burner is set on low, the flame should be just slightly visible when viewed from the side. (See bottom figure at right.)

Note: Flame that is mostly yellow or golden in color is often due to foreign matter in the burner. You may need to clean your burners. See page 23 for instruction on removing and cleaning your burners.

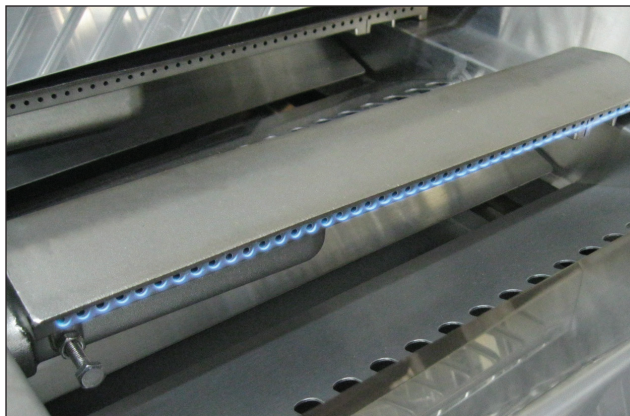

Heat Distribution on the Cooking Grates

When you place food on your Cal Flame grill, remember that the back of the grill tends to be hotter than the front.

As your food cooks, you should periodically shift it to different spots on the cooking grates to ensure everything cooks evenly without burning.

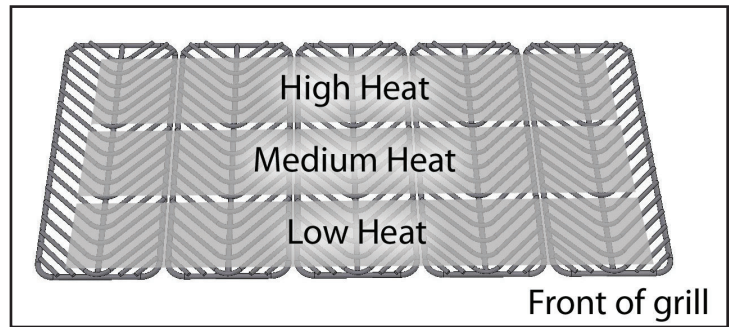

Using the Griddle

When sliding the griddle out of the enclosure, always do it slowly as the heavy weight may cause you to suddenly drop the griddle. Lift the griddle out of the enclosure instead of sliding it all the way out.

Remove two cooking grates for the griddle space. Leave grease in the front drain when cooking. Wait until the griddle cools down when done cooking. Use both hands when removing the griddle and draining the grease.

Before storing the griddle, make sure it is clean and dry. Slide the griddle into the enclosure for safe and easy storage.

Optional Grill Accessories

These grill accessories are optional and may be ordered directly from www.quickbbqparts.com.

Sear Zone Infrared Burner



The Sear Zone infrared burner can be used in place of any regular burner. Producing intense infrared heat, it cooks quickly with searing heat to seal in juices. (Note: The Sear Zone infrared burner is NOT the same as the infrared back burner used with the rotisserie.)

Instructions for installing the optional Sear Zone burner are on page 31.

Pizza Brick Tray



BBQ07900

You can use your grill as a pizza oven using the pizza brick tray. Made of stone and stainless steel, it fits on any Cal Flame grill and is large enough to cook a large sized pizza.

Set the tray on the grates, set the burners to medium heat, and heat up your grill for about 10 minutes. Place the pizza on the tray and close the hood. Depending on the size of the pizza, it will need between 10 to 20 minutes to cook.

Smoke Tray



BBQ08854P

Any burner can be switched to accommodate the Smoke Tray.

1. Remove a grate and a flame tamer (the angular metal piece covering the burner). Do not remove the burner.
2. Set the smoke tray in the grilling area so that the notches in the end rest on the round metal posts attached to the inside of the grill area. The smoke tray will rest over, but not ON, the burners.
3. Place wood chips or charcoal in the Smoke Tray.
4. Replace the grate.
5. Ignite the burner under the Smoke Tray and turn it up to HIGH.
6. Let it burn until the wood chips start to smoke. This should take 7 to 10 minutes. Then lower the heat to low.

Charcoal Tray



BBQ11859

Use Turn part of your Cal Flame grill into a charcoal and gas grill.

Turn off the gas and wait for the grill to cool before setting the Charcoal Tray in place.

Placement

1. Remove two grates (left or right side) and the flame tamers (the angular metal pieces covering the burners). Do not remove the burners.
2. Set the charcoal tray in the grilling area so that the notches in the side rest on the round metal posts attached to the inside of the grill area. The charcoal tray will resting over, but not ON, the burners.
3. Place the ash screen in the Charcoal Tray.

Using the Charcoal Tray

The Charcoal Tray is designed and intended to be used with plain charcoal. Quick-light charcoal can produce excessive heat and may be dangerous.

Make sure the drip tray is in the grill before you begin.

Keep the hood up until you are ready to cook.

1. Arrange charcoal in the tray.
2. Replace the grates.
3. Ignite both burners under the Charcoal Tray and turn them up to HIGH.
4. Let them burn until the charcoal remains lit without help from the burners. This should take 7 to 10 minutes.
5. When the charcoal is ready, turn off the burners.
6. Lower the hood if you wish to use the grill as a smoker.

Removal and Clean-up

When the grill has cooled and the charcoals are dead, clean the grill as described in the grill owner's manual.

Remove ash from the Charcoal Tray immediately after use. Do not let it accumulate. Do not use the grill again until charcoal ash has been removed from the Charcoal Tray and the drip tray.



Never use the Charcoal Tray over a Sear Zone infrared burner.



Never use charcoal in a gas grill without the charcoal tray. Doing so will void your warranty.

Deep Fryer Helper Set



BBQ09902

The Deep Fryer Helper can turn part of your grill into a deep frying station. It is designed to fit in any Cal Flame grill.

The Deep Fryer Helper Set is shipped with its own instructions for placement and use. Read them carefully before use.

The Deep Fryer Helper Set comes with two commercial-sized fryer baskets, a built-in thermometer, and storage hangers allow baskets to be stored within unit. The lid closes and seals for easy storage—wet (with oil) or dry (drained). The lid can be removed for easy cleaning.

Cleaning and Maintenance

To ensure safe and proper maintenance, we recommend you follow these directions carefully.

Clean internal parts of the grill regularly as determined by the amount of use and foods cooked. The entire grill should be cleaned at least once a year.

In addition, keep the area around your grill clear and free from combustible materials, gasoline, and other flammable vapors and liquids. Do not obstruct the flow of combustion and ventilation air.

DISCONNECT ELECTRICAL SUPPLY BEFORE CLEANING ANY PART OF THE GRILL.

These instructions describe the best way to care for your stainless steel. They apply to grills and barbecue islands with stainless steel fixtures.

Although stainless steel grills will discolor and accumulate grime with regular use, they can keep their original shine with periodic cleaning. We strongly

recommend using a surface protectant to prevent smudging and surface rust from accumulating.

The easiest way to clean the grill is immediately after cooking is completed. Doing so will extend the life of your grill, prevent grease fires, and present a pleasant appearance while you grill.

Stainless Steel Care and Cleaning

All exposed stainless steel surfaces require special attention if you want to keep them looking clean and bright. Following these simple instructions will help avoid scratching or damaging the finish and keep your stainless steel attractive.

Cleaning instructions for grill interiors, including racks and burners, are described after this section.

For light soil, use a damp sponge or cloth.

For heavier stains, use a Scotch-Brite scrubber or similar product.

1. Clean

Thoroughly clean stains, food, and grime using a sponge or damp cloth with warm water and a mild dish soap. Use Fantastik or Formula 409 to remove heavier soil.

2. Rinse

Thoroughly rinse all surfaces and dry them completely with a clean towel. Do not allow stainless steel to air dry.

3. Polish

We strongly recommend that you apply a surface protectant to all exposed stainless steel surfaces.

Spray a small amount of WD-40 or Sheila Shine on a piece of paper towel and rub with the grain over the surface of the appliance. Using a clean terry cloth or paper towel, polish the appliance by rubbing with the grain until excess liquid is removed and the surface shines. It should not be oily to the touch, however some residue is acceptable.

Furniture polish, such as Old English, can be effective for polishing stainless steel and protecting the surface.

Caution

Do not use Instant Rust Out, WD-40, or Sheila Shine near food or on food preparation surfaces as it is a health hazard. This includes the interior of the grill, grill racks, stainless steel sinks, the inside of cabinets, warming drawers, and ovens.



Fire Hazard

NEVER spray WD-40 or Sheila Shine near an open flame! These products are extremely flammable while in their aerosol forms.

Rust Removal

It is a common misconception that stainless steel does not rust. It does not stain, corrode, or rust as easily as ordinary steel (it *stains less*), but it is not stain-proof. If not properly protected and maintained, it can corrode, pit, and discolor.



Important

Because salt will accelerate rust and corrosion, grill or barbecue island owners who live near the beach need to be diligent in maintaining their stainless steel hardware. You need to clean and polish your stainless steel frequently, apply a protectant, and ensure water does not collect and

puddle.

There are two methods of rust removal we recommend:

1. Rust removal with Instant Rust Out:

Spray exterior stainless steel surfaces with Instant Rust Out. Let it stand for about 30 seconds, then wipe with a clean cloth. Apply a second time if necessary.

Instant Rust Out will leave a white residue which can be rinsed off with water. Wipe the grill dry with a clean cloth and apply Sheila Shine or WD-40 as a surface protectant.

2. Rust removal with WD-40 or Sheila Shine:

Spray exterior stainless steel surfaces with WD-40 or

Sheila Shine and wipe down with a dry cloth or paper towel until surface is free of rust. If there is significant rust or corrosion, use a Scotch-Brite scrubber.

Both of these products will act as a surface protectant and help resist smudges, stains, and rust.



Caution

Although nitric acid (also called aqua fortis) can be effective for rust removal, it is a highly corrosive chemical. Because of the potential for injury or damage to your stainless steel, we do not recommend using nitric acid.

Cleaning the Interior of Your Grill

1. Thoroughly clean stains, food, and grime using a sponge or damp cloth with warm water and a mild dish soap. Use Fantastik or Formula 409 to remove heavier soil.
2. Thoroughly rinse all surfaces and dry them completely with a clean towel. Do not allow water to accumulate and puddle on stainless steel. Water from various sources such as garden hoses contains iron which will give the appearance of rusting on stainless steel. If allowed to stand for long periods of time on stainless steel, it will cause pitting.
3. The racks, flame tamers, and flavor bars can all be removed for cleaning and are dishwasher safe.

Burners

Spiders and small insects occasionally inhabit or make nests in the burner tubes, obstructing the gas flow. Sometimes this results in a type of fire in and around the gas tubes called "flashback". To reduce the risk of flashback, this procedure should be followed at least once a month or when your grill has not been used for an extended period of time.

Cleaning Products and Materials

DO NOT USE these common cleaning products and materials – they will damage the surface of your stainless steel.

- CLR
- Lime-Away
- Oven cleaner
- Cleansers such as Ajax or Comet
- Ammonia
- Bleach
- Chlorine
- Steel wool pads
- Wire brushes
- Scrapers
- Pumice

We recommend these products for cleaning your

stainless steel:

- Mild dish detergent such as Dawn
- Formula 409
- Fantastik
- Instant Rust Out (exterior ONLY)
- WD-40 (exterior ONLY)
- Sheila Shine (exterior ONLY)

We have had best success with Instant Rust Out, but WD-40 works very well too. Instant Rust Out is available in some hardware stores. WD-40 is widely available.

Baking soda, lemon oil, olive oil, vinegar, or club soda can also be effective for cleaning light soil on all stainless steel surfaces.

Do not use steel wool or wire brushes to scrub your grill.

IMPORTANT: Prior to starting this procedure, turn OFF all of the gas control knobs, shut off the fuel supply, and disconnect the fuel line.

The burners can be removed by removing the locking pins and lifting them out. The locking pins are located under the grill toward the back. They are used to keep the burners in place during shipping and are not necessary to operate your grill. Remove burners from the grill by carefully lifting each burner up and away from the gas valve orifice.

Use a wire brush to clean the outer surface of each burner to remove food residue and dirt. Clean any clogged ports with a stiff wire such as an opened paper clip.

Inspect each burner for damage (cracks and holes). If any damage is found, discontinue grill usage until you replace the burner.

Upon reinstallation, inspect the gas valve orifices for cleanliness and condition and the location of the igniters. When you replace the burners, you do not need to replace the locking pins.

Cooking Grates

Use a solution equal parts detergent and hot water just as you would for any cooking equipment. A stiff wire brush or steel wool may also be helpful in removing grime and food deposits.



Note

Do not use a wire brush or stainless steel on any other part of your grill or any other stainless steel surface except the cooking grates or the griddle!

Drip Pan

The full width drip pan will collect grease from the main grill area. The pan should be cleaned after every use to avoid the possibility of a grease fire. Be sure to allow the drip pan to cool prior to cleaning. You may clean the drip pan with a solution of warm soapy water. Make sure to rinse thoroughly to avoid staining.

Griddle

To prevent burns or injury, make sure the griddle is completely cool before cleaning.

The griddle is made from non-magnetic, 304 grade stainless steel. There are various stainless steel cleaners available. Always use the mildest cleaning procedure first, and always scrub in the direction of the grain. Use soapy water for most cleaning. A non-abrasive scrubber may also be helpful in removing grime and food deposits. Steel wool may be used for especially difficult spots. Wipe all areas dry before storing.

Steam Cleaning Your Grill

Steam cleaning the interior of your grill is very effective and will not void your warranty. Portable hand-held steam cleaners are inexpensive and do not require chemicals. You can steam clean all parts of your Cal Flame grill, including the burners. When you are finished, make sure you wipe all surfaces down.

If you spray the burners, ignite them and let them burn for about 10 minutes to prevent any water from accumulating inside them.

Covering Your Grill

When not in use and after cooling, cover your grill with our full length, zippered side canvas cover. (See your local Cal Flame dealer for details.) The cover will help protect your grill from detrimental effects of weather and environmental pollutants. Never put a cover on a hot grill. Allow the grill to cool before covering.

Seasonal Cleaning

If you haven't used your grill in a few months, we recommend that you clean the burners and the interior of your grill. Cleaning the burners periodically will keep them burning evenly and cleanly and help prevent "flashback", a type of fire in and around the gas tubes. This happens when spiders and small insects inhabit or make nests in the burner tubes, obstructing the gas flow.

IMPORTANT: Before removing the burners, turn OFF all of the gas control knobs, shut off the fuel supply, and disconnect the fuel line.

1. Remove the components

Remove the racks, the flavor bars, and the flame tamers from the grill and set them aside. They don't need to be in the grill in order to clean them. In fact, all of the items can be cleaned in a dishwasher if you wish.

Leave the drip pan in place for now.

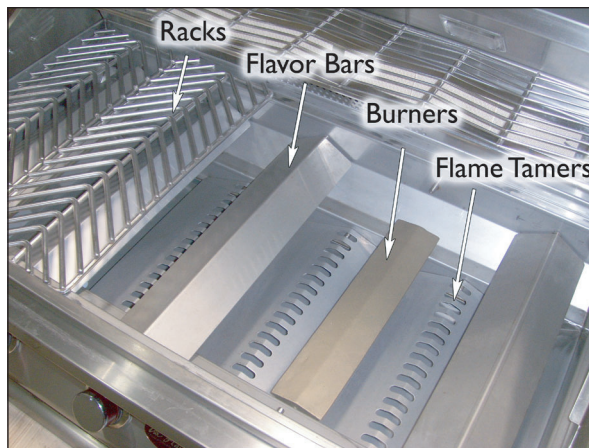

2. Remove the burners

The burners can be removed by taking out the locking pins and carefully lifting them up and away from the valve orifice. The locking pins are located under the grill toward the back. They are used to keep the burners in place during shipping and are not necessary to operate your grill.

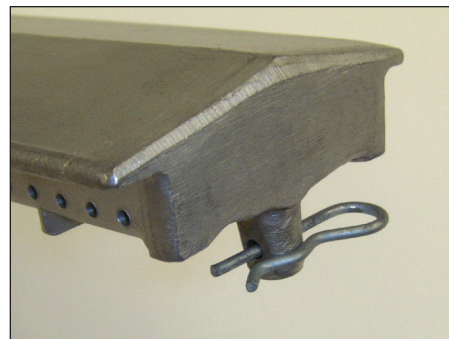

3. Clean the burners

Use a wire brush to clean the outer surface of each burner to remove food residue and dirt. Clean any clogged ports with a stiff wire such as an opened paper clip.

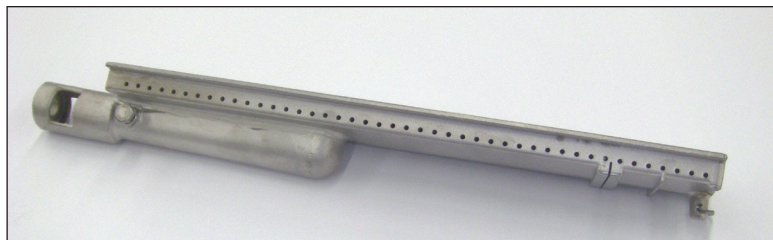

Make sure the flow channel is clear. The flow channel is the narrow slot on the bottom of the burner near the anchor post.

Inspect each burner for damage, such as cracks and holes. If any damage is found, don't use the grill until you replace the burner.

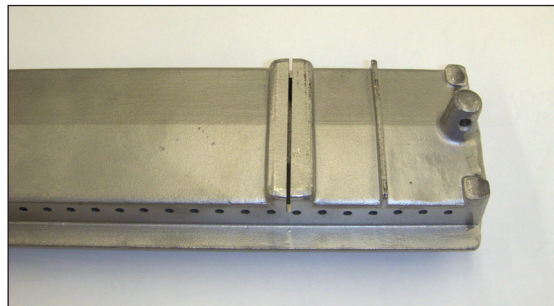

4. Clean the grill interior

While the burners are out of the grill, you can use this opportunity to clean the interior of your grill thoroughly. You should still have the drip pan in place to catch water and grime as you clean the grill interior.

When the grill interior is clean, remove the drip pan. Dump out any water and grime residue and spray it off with a garden hose.

Dry both the grill interior and the drip pan thoroughly to prevent water damage.

5. Clean the components

You can clean the racks by first soaking them in warm water and dish detergent and scrubbing them with a wire brush.

Clean the flavor bars and the flame tamers with dish detergent. You can use any kind of scrubber you wish: a non-abrasive pad, steel wool, or a wire brush, depending on your needs.

Dry all of the components thoroughly to prevent water damage.

6. Replace the burners

Before you replace the burners, inspect the gas valve orifices for cleanliness and condition and the location of the igniters.

Set the flame tamers in place before you replace the burners.

Carefully insert the burner into the opening for the valve orifice and gently slide it in. Then set the other end of the burner down so the anchor post rests in the hole.

When you replace the burners, you don't need to replace the locking pins.

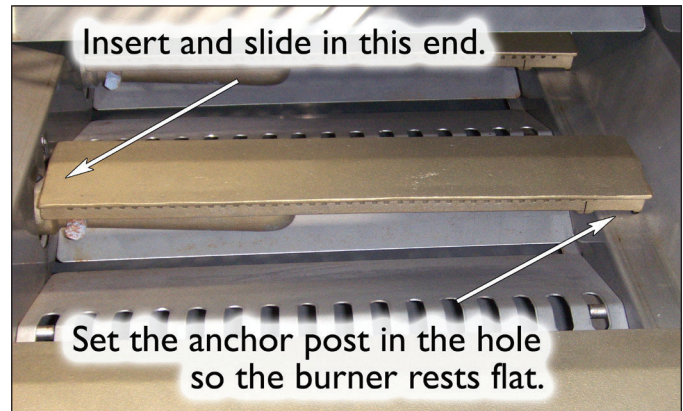

7. Replace the components

Put all of the components back as they were, as shown in step 1.

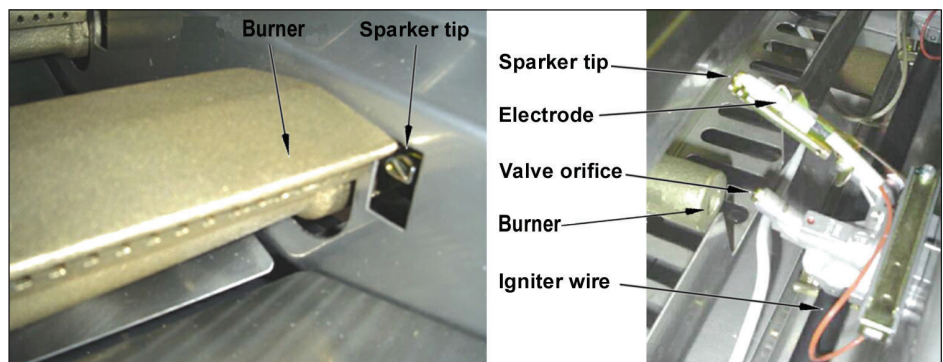

Troubleshooting

Problem: Smell of gas is present

Solution: Check for loose connections in the gas line. Perform a leak test following the procedure described in this manual.

Problem: Burner does not ignite

Solution: Note: Turn off the gas at the source while troubleshooting.

Use the following procedure with the figure below.

Check the position of the sparker tip. It should be pointing forward towards the front of the burner.

- Make sure there is a blue spark at the electrode tip to the burner.
- Make sure the igniter wire is connected firmly to the valve ignition device and the electrode.
- Make sure the valve orifice is free of any debris, dust or grease.
- Make sure the valve orifice is aligned inside the front hole of the burner.
- If there is no spark at all, replace the electrode or igniter wire.

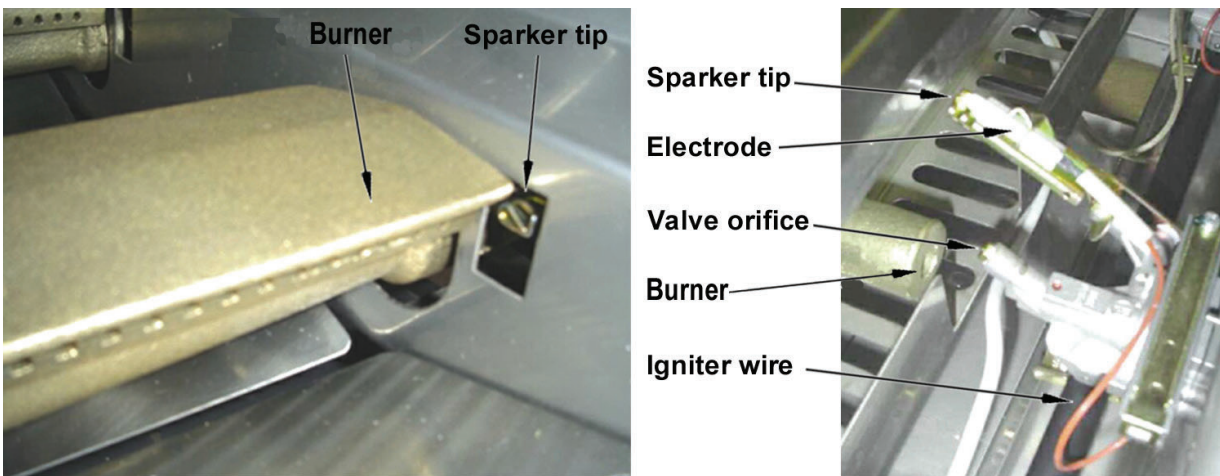

Problem: Burner tube is misaligned over the orifice

Solution: Reposition the burner tube so that it is properly seated over the orifice.

Problem: Obstruction in the gas line

Solution: Remove the fuel line from grill. (Do not smoke or perform any maintenance in the vicinity of an open flame.) Open the gas valve for one second to blow out any debris. Close off the gas valve and reconnect the fuel line securely. Let the area ventilate for a few seconds before reconnecting the fuel line.

Problem: Yellow Flame

Solution: Once the entire burner is operating, check the flame color to be sure that it is mostly blue. Some yellow at the tips may be present due to impurities in the fuel. If the flame is golden or yellow in color, the reason could be seasoning salts, oil film, or other foreign matter on the burner.

Problem: Plugged orifice

Solution: Unplug the orifice as follows:

- Remove cooking grills, flame tamer and grease tray.
- Remove burners from the bottom of the firebox by pulling the locking pin from beneath the burner peg using a standard screwdriver or needle nose pliers.
- Carefully lift each burner up and away from the gas orifice.
- Remove the orifice from the control valve.
- Gently clear any obstruction with a fine wire.
- Reinstall the orifice, reinstall the burners over the orifices, and seat each burner peg into position hole at the bottom ledge of the firebox.
- Replace cooking components and grease collectors.

If an obstruction is suspected in the control valve, contact your local Cal Flame dealer for assistance.

Problem: Misalignment of Igniter on Burner

- Solution:**
- Check for proper position of the electrode tip, which should be pointing forward towards the front of the burner and free of grease to allow proper sparking.
 - The ignition wire should be connected firmly to the valve ignition device and electrode. Replace the ignition wire if it is frayed or cracked.
 - With the gas supply closed and all control knobs set to the off position, check each position igniter individually for the presence of a spark at the electrode. Push each knob in fully and rotate it about 1/4 turn to the left (counter-clockwise) until you hear a loud click. The trigger hitting the strike block should produce a blue spark at the electrode tip. Return control knob to the off position before checking the next igniter.
 - While the grill is still hot, wait for a minimum of five minutes before commencing re-ignition. (This allows accumulated gas fumes to clear.) If all checks / corrections have been made and the gas grill still fails to operate properly, contact your local Cal Flame dealer.

Problem: Flashback

Solution: When fire occurs in and around the burner tubes, immediately turn off gas at its source and turn the control knobs clockwise to the 'OFF' position. Wait until the grill has cooled off and then clean the burner tubes and burners as described on page of this manual.

Converting from LP to NG



WARNING! You must have an authorized service technician perform this procedure. If these instructions are not followed exactly, a fire or explosion may result causing property damage, personal injury or loss of life. Lloyd's Material Supply Company, Inc. will not be held responsible for an improperly converted gas grill.

IMPORTANT: The grill that comes with your B470 barbecue island does not include the parts for converting to NG. The gas conversion kit for Cal Flame grills can be ordered separately. Ordering information can be found in this manual on page 29. The part number for the conversion kit is BBQ07101045.

All Cal Flame grills are manufactured as standard liquid propane (LP) grills and can be converted to burn natural gas (NG). There are two steps required to convert a grill from LP to NG.

You must perform both steps.

Step 1: Switching the regulator behind the grill

Step 2: Changing the burner orifices

The conversion kit provided with your grill may include **some or all** of the parts shown at right, depending on the size and model of your grill.

The kit contains orifices to convert main burners. Your kit will have only the parts you need to convert your grill.

Before you begin, make certain the LP gas source has been disconnected from the grill.

To gain access to the NG regulator, tilt the grill forward.



1.9 mm orifices for main burners (two to five pieces)



1.75 mm orifices for side burners (one to two pieces)

NOTE: A flared fitting is NOT included with your grill.

If you are attaching a flex hose to the regulator, you will need a fitting. The fitting requires a male flare on the input end with a 1/2" MPT on the output end. The flared male input end needs to be the size of your flex tubing. You can also connect the regulator directly to your NG gas service, which will not require a flared fitting.

Step 1: Attach the regulator to the manifold

The manifold in the image below has been removed from a grill to illustrate this procedure.

1. Remove the elbow fitting from the end of the manifold.
2. Attach the NG gas regulator. Make sure you use Teflon tape or plumber's dope.

You will need:

- 13mm open end wrench
- Male flared fitting
- Pipe compound suitable for natural gas

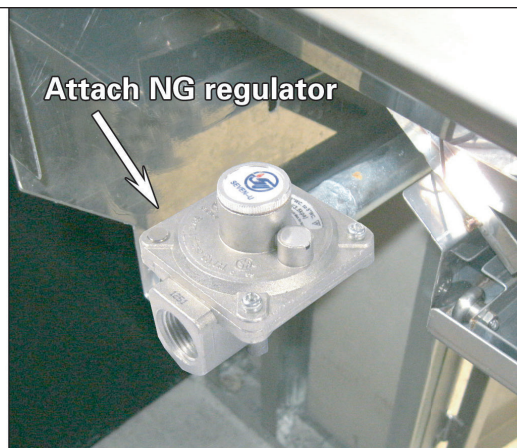

Step 2: Changing the burner orifices

- a. Remove the grates, flame tamers, and drip tray from the grill. See figure below.

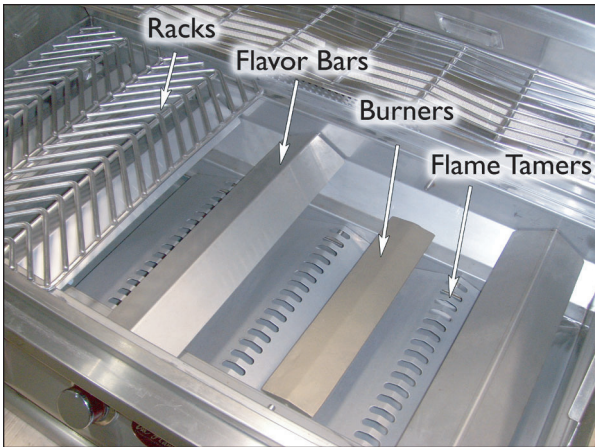

- b. Remove the locking pins from the end of the burners.

The locking pins are accessible by removing the drip tray and tilting the grill back. They can be seen underneath the grill in the back. See figures below.

- c. Remove all burners by carefully lifting them up and away from the valve orifice.

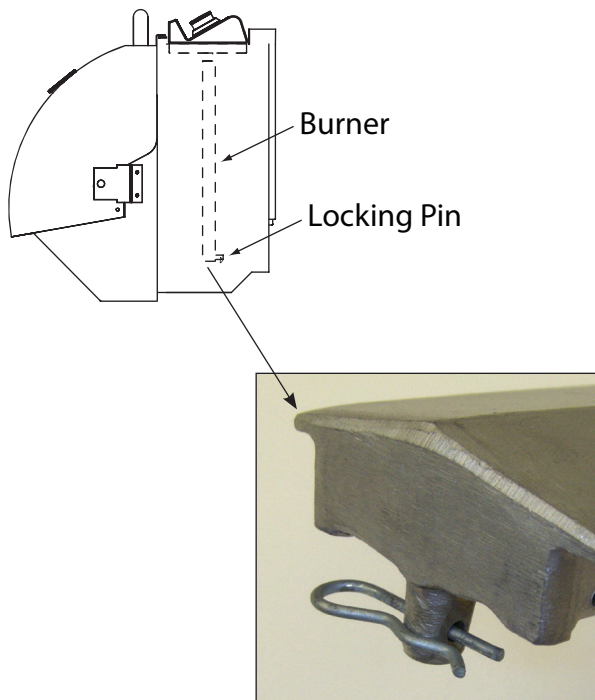

You will need:

- 6mm socket or nut driver
- Two to five 1.9mm orifices (depending on your grill)
- Pipe compound suitable for natural gas

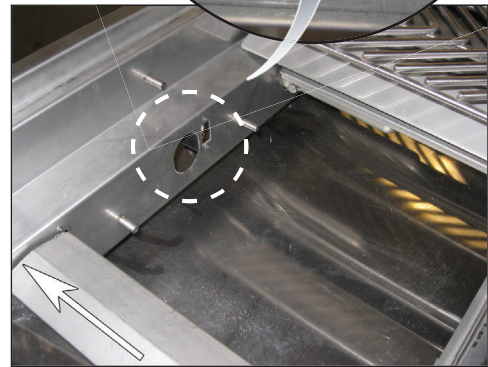
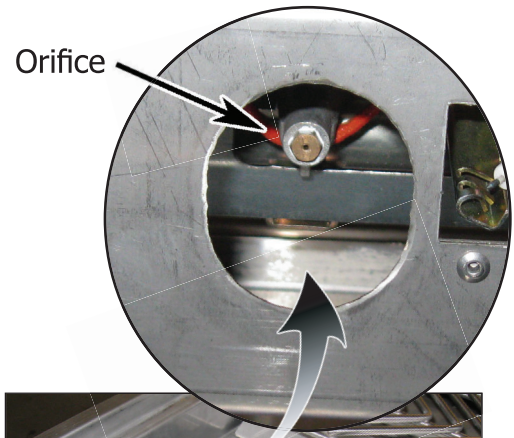

- d. Using a 6mm socket or nut driver, remove the orifice for the burner.
- e. Apply a small amount of pipe compound to the orifice threads.
- f. Screw in the orifice until it is finger tight.
- g. Tighten the orifice with the 6mm wrench.
- h. Repeat the above steps for the remaining burners.
- i. Replace the burners, flame tamers, drip tray, and grates.

You do not need to replace the locking pins. They are used to keep the burners in place during shipping and are not necessary to operate your grill.

After conversion has been completed, mark the rating plate as NG with an indelible marker.

Replacement Parts

See following page for part numbers. To order replacement parts:

- contact an authorized selling dealer
- Call LMS Customer Service at (800) 225-7727
- Visit us at www.quickbbqparts.com

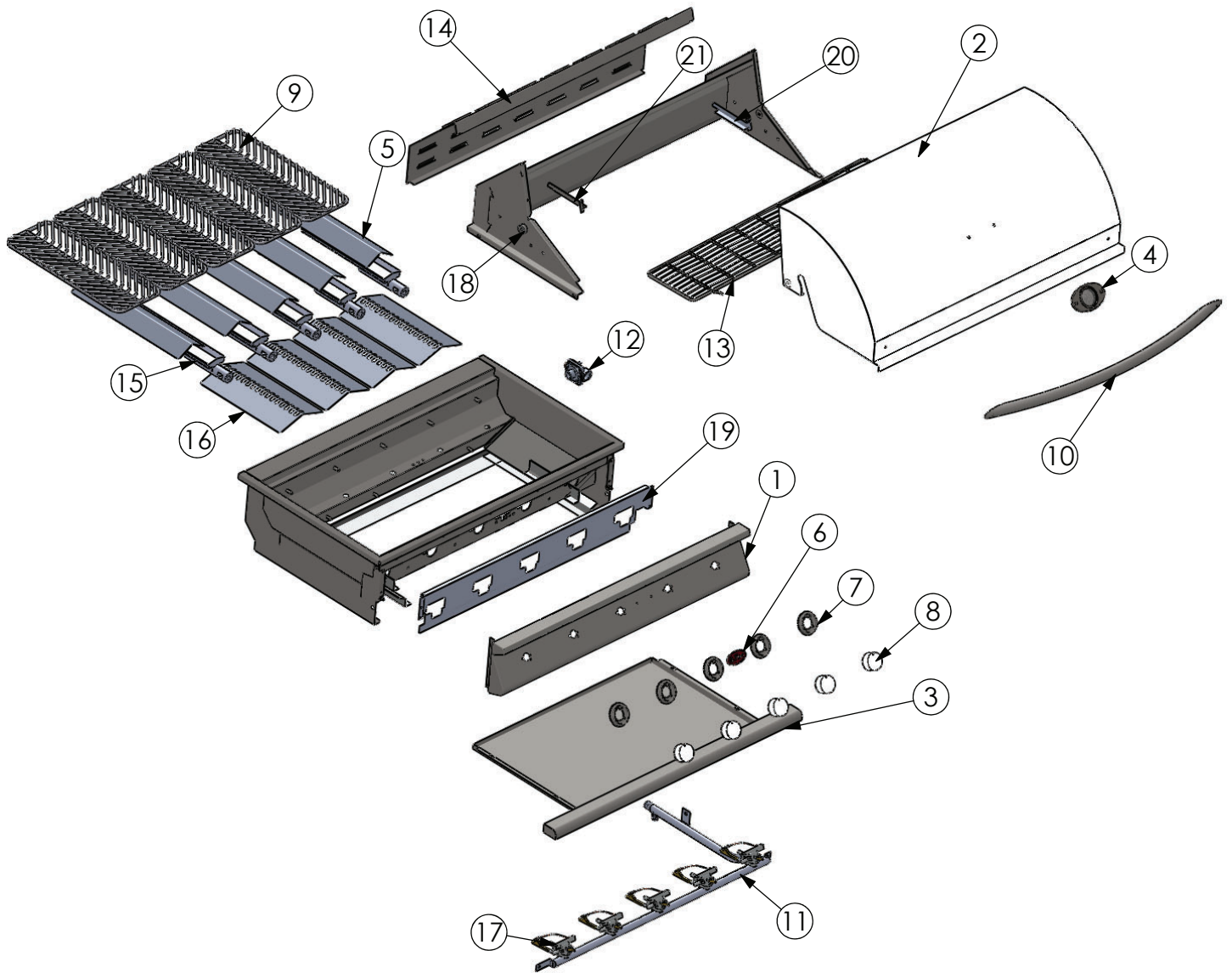

All parts can be used on all three grill sizes except where described below.

Item No.	Part	Grill Size	Part #
1	Control panel	3 burner	BBQ10104049-CC
		4 burner	BBQ07104050
		5 burner	BBQ09104051-CC
2	Hood	3 burner	BBQ07100587-CC
		4 burner	BBQ07100588-CC
		5 burner	BBQ07100589-CC
3	Drip pan	3 burner	BBQ07100686
		4 burner	BBQ07100687
		5 burner	BBQ07100688-CC
4	Thermometer	All	BBQ07410350
5	Flavor bar	All	BBQ04103000
6	Cal Flame logo	All	BBQ04100972
7	Bezel	All	BBQ08410351
8	2" knob	All	BBQ04101028
9	Grates	All	BBQ04100659
10	Handle	3 burner	BBQ07100683
		4 burner	BBQ07100639
		5 burner	BBQ07100641
11	Manifold	3 burner	BBQ08000510
		4 burner	BBQ08000511
		5 burner	BBQ08000512
12	Regulator (LP)	All	BBQ04101043
	Regulator (NG)	All	BBQ04103040
13	Warming rack	3 burner	BBQ08100656-CC
		4 burner	BBQ01000657-CC
		5 burner	BBQ08100658
14	Back panel	3 burner	BBQ07104053
		4 burner	BBQ07104054
		5 burner	BBQ07104055
15	Burner	All	BBQ07100662
16	Flame tamer	All	BBQ04103010-CC
17	Main burner valve (LP)	All	BBQ04101016
	Main burner valve (NG)	All	BBQ04101015
18	Hood hinge	All	BBQ04101257
19	Heat shield panel	3 burner	BBQ07220172
		4 burner	BBQ07220170
		5 burner	BBQ07220171
20	Warming rack bracket, right side	All	BBQ04100707
21	Warming rack bracket, left side	All	BBQ04100706
--	Grill cover (not shown in drawing)	All -- one size fits all	BBQC2345GB
--	LP to NG gas grill conversion kit	All	BBQ07101045

Installing Sear Zone Burners

1. Disconnect or shut off the LP or natural gas line connected to the grill. Wait until the burners cool down.
2. Open the hood and remove the grate and flame tamer on top of the stainless steel burner you want to replace.
3. Through the access door underneath the grill, find the round stud and locking pin that locks the burner you want to replace.
4. Carefully remove the locking pin with your fingers.
5. Raise the stud from the locking hole and carefully move the burner forward to release it from the igniter and gas supply valve.
6. Take the burner out of the grill and store it in a safe and dry place.
7. Install the Sear Zone burner. Align the gas inlet on the burner with the gas supply valve on the grill and torch tube with the igniter. Make sure they align perfectly. Slide the stud at the other end into the locking hole.
8. Adjust the Sear Zone burner, make sure the burner is aligned and in position.
9. Install the locking pin. Through the access door underneath the grill, find the stud to lock the burner in place, install the locking pin. Make sure the locking pin is secured correctly.
10. Repeat steps 2 through 9 if you want to replace other burners.

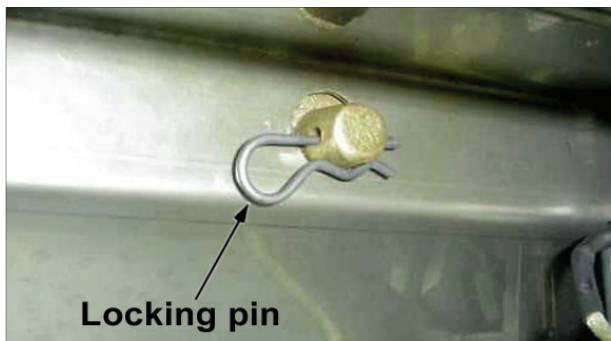
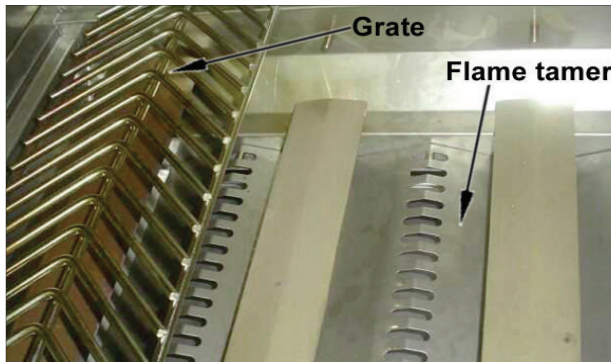

11. Put back the grate you just removed. (You don't need flame tamers for Sear Zone burners.)
12. Reconnect or turn on the gas line.

If you want to change Sear Zone burners to regular burners, just follow the above procedure above in a similar way.

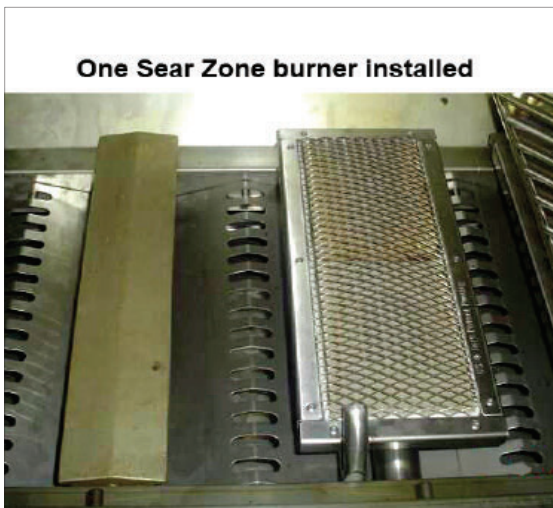

LIMITED WARRANTY

This Limited Warranty is extended to the original purchaser of a B470 barbecue island package manufactured after January 1, 2023 and installed for residential use in the United States of America and Canada. This warranty begins on the date of delivery, but in no event later than one year from the date of manufacture.

Barbecue Island Warranty

Lloyd's Material Supply Company, Inc. warrants barbecue islands from deterioration, corrosion, and defects in material and workmanship for a period of one year from the original date of delivery.

G4 Grill Warranty

Lloyd's Material Supply Company, Inc. warrants the G4 grill from defects in material and workmanship for a period of one year.

Extent of Warranty

This limited warranty is only valid on Cal Flame models delivered in the United States or Canada and extends through the selling dealer to the original purchaser at the original site of installation.

Warranty Performance

In the event of a malfunction or defect covered under the terms of this warranty, contact either the selling dealer or a local contractor or service technician. Depending on your needs, this may be a contractor qualified to repair stone and tile or a service agent licensed to repair gas or electrical appliances.

In the event the consumer is unable to obtain satisfactory customer service from the selling dealer or service agent, written notification must be given to the Lloyd's Material Supply Company, Inc. Customer Relations Department within 30 days of the reported failure.

There will be no charge for parts on a covered item. Cost of labor is the responsibility of the owner. Shipping and handling charges will apply to all warranted replacement parts. The service agent may assess a reasonable travel or mileage charge per service call. If Lloyd's Material Supply Company, Inc. determines that repair of a covered item is not feasible, Lloyd's Material Supply Company, Inc. reserves the right to replace the defective merchandise instead. Warranty repair and / or replacement are the sole discretion of Lloyd's Material Supply Company, Inc. and this warranty does not cover costs therein, including but not limited to: freight, removal, re-installation, etc.

This warranty is non-transferable and may not be extended beyond the above mentioned time frames under any circumstances, by any of Lloyd's Material Supply Company, Inc. representatives.

Warranty Limitations

This warranty is void if the barbecue island has been subject to negligence, alteration, misuse, repairs, dings, dents, scratches, or incorrect and / or prohibited applications, as specified in the owner's manual. Gas lines must be installed by a licensed plumber only or local gas company agent. Incorrect electrical installation by unlicensed electricians, service by non- Lloyd's Material Supply Company, Inc. authorized representatives, acts of God and other cases beyond the control of Lloyd's Material Supply Company, Inc. are not covered by this warranty. Please refer to the owner's manual for examples of exclusions and common acts invalidating this warranty. This limited warranty applies only to barbecue islands used for personal, family, and outdoor household purposes. This warranty does not apply to labor charges on barbecue islands, replacement parts and hardware. This limitation is retroactive and applies to all barbecue islands manufactured from 2000 and hereafter.

Examples of common acts invalidating this warranty include but are not limited to:

- Scratches caused by normal use.
- Damage caused by extreme weather conditions (hot, cold, etc.)
- Damage caused by dirt, sand, and/or water damage.
- Damage caused by salty and humid conditions (especially in beach or seaside communities)
- Damage caused by continued operation of the barbecue with either known or unknown problems.
- Damage caused by direct sunlight.
- Damage caused as a result of failure to follow the operating instructions as defined in this owner's manual.

This limited warranty applies only to barbecues normally used for personal, family, or household purposes and

specifically excludes rental or commercial applications.

Disclaimers

Lloyd's Material Supply Company, Inc. shall not be liable for loss of use of the barbecue islands or other incidental or consequential costs, expense or damages, which may include, but are not limited to, removal of permanent deck or other custom fixtures or the necessity for crane removal. Any implied warranty shall have duration equal of the applicable warranty stated above.

Natural stone: Rock, travertine, marble, granite, etc. may be characterized by dry seams, pits, chips, cracks, and fossils that are often filled with grout during installation. These are normal imperfections and are not considered defects.

Legal Remedies

This limited warranty gives you specific legal rights. You may have other rights, which may vary from state to state.

Customer Service

For customer service, contact the authorized selling dealer immediately. If you need additional information or assistance, please contact the Lloyd's Material Supply Company, Inc. Customer Relations Department at 1462 E. Ninth St., Pomona CA 91766 or call (800) 225-7727.

See your Cal Flame barbecue dealer for a copy of the applicable warranty, details and any questions you may have regarding the warranty coverage on your barbecue.

Locating the product serial number

The serial number of your Cal Flame grill is located on the back and is visible when the hood is down. You will need this number to properly register your grill and activate coverage. Write this information in the space provided below.



Grill model: _____

Grill serial number: _____

Type of fuel (circle one): Liquid propane Natural gas

Date purchased: _____

Date installed: _____

Cal Flame dealer's phone number: _____

Cal Flame dealer's address: _____

**Don't forget to register your new product at
www.calflamebbq.com.**



WARNING! Proposition 65 Warning: Handling the brass material on this product exposes you to lead, a chemical known to the State of California to cause cancer, birth defects or other reproductive harm. (Wash hands after handling this product.)

This product and the fuels used to operate this product (propane or natural gas), and the products of combustion of such fuels, can expose you to chemicals including Benzene, which is known to the state of California to cause cancer and birth defects or reproductive harm.

For more information go to www.P65Warnings.ca.gov.

1462 East Ninth Street
Pomona, CA 91766.

Toll Free: 1-800-225-7727
Fax: 1-909-629-3890